

CE

# AIR RELAX<sup>®</sup> PLUS

## USER MANUAL

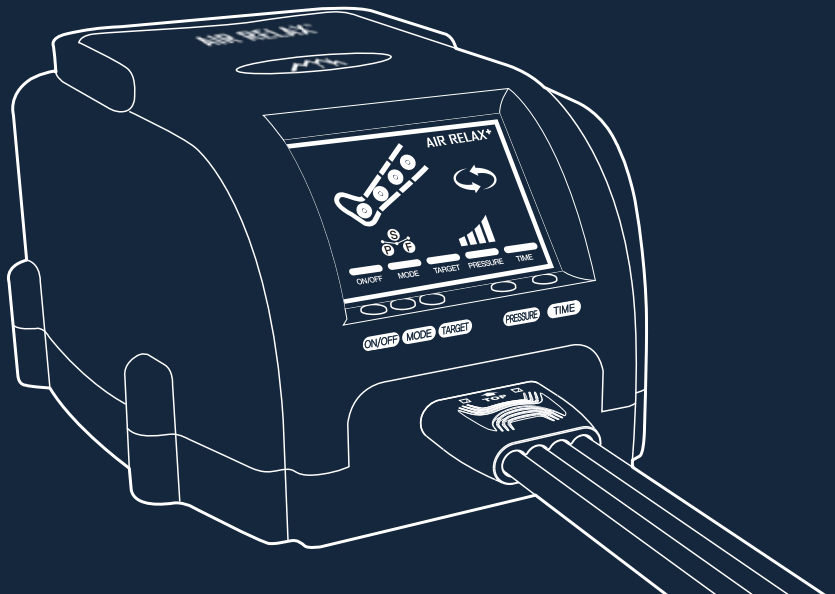

Read all instructions before using the Air Relax Plus system. Keep this manual near to the system for quick reference. This manual presents details required by users to prevent any danger or property loss for safe use of this system.

MODEL AR-3.0

# TABLE OF CONTENTS

---

Table of Contents .....	02
Safety Information .....	03
Labels .....	06
Indications for Use and Contraindications .....	07
Operation and Components .....	08
Display Screen .....	09
Operation Buttons .....	10
Operation Cycles .....	12
How to Use the Air Relax Plus System .....	14
Maintenance and Storage .....	19
Troubleshooting .....	20
Warranty .....	21
Return Policy .....	22
Specifications .....	23
Electromagnetic Compatibility .....	24

# SAFETY INFORMATION

---

## **WARNING**

- For your safety and to avoid property damage, please read this manual carefully and use as indicated. Non-Compliance may cause serious injuries or death and or severe property damage. Do not use the system in any way other than the usage stated in the manual.
- Do not use this system if you are experiencing inflammation, an infection, open wounds or bleeding at or near the site of application.
- This appliance can be used by children aged from 8 years and above and persons with reduced physical, sensory or mental capabilities or lack of experience and knowledge if they have been given supervision or instruction concerning use of the appliance in a safe way and understand the hazards involved.  
Children shall not play with the appliance.  
Cleaning and user maintenance shall not be made by children without supervision.

## **WARNING**

- Keep the system, including hoses and cords, away from children and pets.
- Do not use the system in the presence of flammable gases, including flammable anesthetics.
- Do not use any AC Adapter other than that provided by Air Relax. Use of other adapters may result in **electrical shock** and will void the Air Relax warranty.
- Do not modify any part of the system.
- Do not use the system on heat generating material. This may cause the battery pack to overheat and cause malfunction or overheating.
- Do not drop, use any excessive force or place heavy weight upon the system. This may cause system malfunction and/or damage.

# SAFETY INFORMATION

---

## **WARNING**

- Do not keep the system near high magnetic fields or where it can be affected by a magnetic field, for it can cause batteries to discharge.
- To avoid the risk of **electrical shock**, do not open any panels from the control unit. Opening the case will void the Air Relax warranty. All maintenance tasks should be performed only by authorized service personnel.
- To avoid the risk of **electrical shock**, always turn off the system and disconnect the power line cord from its electrical outlet when not in use.
- To avoid the risk of **electrical shock**, do not use the system in near water, such as a kitchen, bathroom, sauna, or swimming pool.
- Keep the system away from heating appliances such as ovens, microwaves, hot cooking utensils, or high pressure cookers. This may cause a degradation of the battery pack and/or system malfunction.
- If the battery pack is not in use for extended duration, charge the unit once every month. If the batteries remain discharged too long, this may degrade the life cycle and performance of the battery pack.
- This battery pack contains a Lithium-Ion battery. Dispose of this battery pack in accordance with local regulations.
- This system is intended for consumer home use. Commercial use will cause premature breakdown of the system.

---

 **WARNING**











- If you experience severe pain, any abnormal symptoms, or want to remove pressure in an emergency during use, stop the system by pressing the power button and remove the garment(s) from your limb and consult your licensed healthcare practitioner, as required.
- Stop treatment in case of any change of the system performance.











 **CAUTION**

- Do not use the system beyond the specified temperature range: +50 °F to +104 °F (+10 °C to +40 °C).
- Do not use the system beyond the specified humidity range: 35 %R.H. – 85 %R.H., non-condensing, but not requiring a water vapor partial pressure greater than (5,000 Pa) and an atmospheric pressure range of (800 hPa to 1060 hPa).
- To prevent any damage to the system, keep it away from dust, lint, or any dirt.
- Use only accessories approved by the Manufacturer. Other accessories may damage the system or interfere with system function.
- The garment is not sterile, do not place directly against open wounds, sores, rashes, infections, or stitches. The garment may be applied over clothing.
- A layer of clothing between garment and skin is recommended.

# LABELS

The following labels and symbols appear on the control unit, battery pack, garments, and/or packaging.

SIMBOL	DESCRIPTION	LOCATION
	Follow instructions for use	On base of control unit
	Read instructions before use	On base of control unit and garment tag
	Double Insulation	On base of control unit
	Direct current	On base of control unit
	Manufacturer	On base of control unit and garment tag
	Date of Manufacture	On base of control unit
	Separate collection for waste electrical and electronic equipment	On base of control unit and battery pack
	Serial number of the control unit	On base of control unit
	Keep away from sunlight	On base of control unit and package
	Keep dry	On base of control unit and package
	Transportation & storage temperature limitation	On base of control unit and package

SIMBOL	DESCRIPTION	LOCATION
	Transportation & storage humidity limitation	On base of control unit and package
	Transportation & storage atmospheric pressure limitation	On base of control unit and package
	Fragile, handle with care	On package
	This side up	On package
	Do not wash	On garment tag
	Do not dry-clean	On garment tag
	Do not tumble dry	On garment tag
	Do not bleach	On garment tag
	Do not iron	On garment tag
	Warning symbol	In manual
	Caution symbol	In manual

# INDICATIONS FOR USE

---



The Air Relax Plus powered inflatable tube massager is indicated for the temporary relief of minor muscle aches and pains, and for temporary increase in circulation to the treated areas in people who are in good health. The Air Relax Plus simulates kneading and stroking of tissues by using an inflatable garment.

## CONTRAINDICATIONS

---

- Do not use this system if you are experiencing inflammation, an infection, open wounds or bleeding at or near the site of application.
- Do not use this system on sensitive skin, swollen or inflamed areas, in the presence of poor circulation, where skin eruptions are present, or in the presence of unexplained calf or abdominal pain.
- Do not use this system if you are under the care of a physician or have a contraindication requiring the use of any medical device.
- Do not use this system if you have any of following conditions:
  - Acute pulmonary edema
  - Acute thrombophlebitis
  - Acute congestive cardiac failure
  - Acute infections
  - Osteoporosis
  - Deep vein thrombosis (DVT)
  - Episodes of pulmonary embolism
  - Wounds, lesions, or tumors at or near the site of application
  - Where increased venous and lymphatic return is undesirable at or in the vicinity of the treatment application because of lesions or tumors.
  - Bone fractures or dislocations at or near the site of application
- Do not use during pregnancy. Pregnant women should consult their health care provider before using this system.
- Do not use if you have blood clotting or subject to blood clotting.
- This system does not constitute medical treatment and is not a substitute for a medical examination or diagnosis. If you are dealing with a serious health condition check with your health care provider before using.

# OPERATION

The Air Relax plus control unit takes air from the surrounding environment and sends it through silicon hoses into four individual air chambers inside of the Air Relax Plus garment.

## COMPONENTS

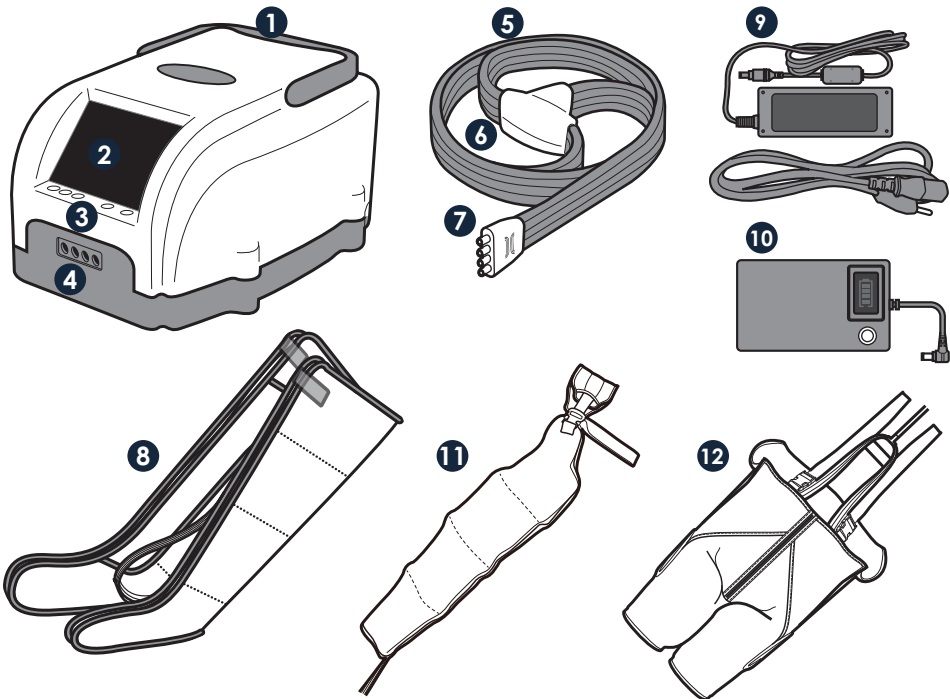

- 1. Handle
- 2. Display Screen
- 3. Operation Buttons
- 4. Air Socket
- 5. Silicone Hose
- 6. T Connector

- 7. Hose Plug
- 8. Leg Garments
- 9. AC Adapter
- 10. Battery Pack (Optional)
- 11. Arm Garment (Optional)
- 12. Shorts Garment (Optional)



# DISPLAY SCREEN



- **CHAMBERS** : Displays four individual air chambers, as the display lights up the chamber that is displayed will fill with air.
- **ON/OFF** : Displays the power status.
- **MODE P,S,F** : Displays the operation cycle mode that is currently selected.
- **TARGET** : Displays status of TARGET operations.  
Selected area on the chamber lights up.
- **PRESSURE** : Displays the level of air pressure.
- **TIME** : Displays and operates when the TIME button is pressed. When selected, the Time Display lights up to indicate 30 minutes session in operation.

# OPERATION BUTTONS

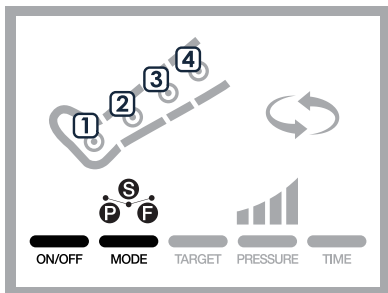

- 1
- 2
- 3
- 4
- 5

## 1 ON/OFF Button

- Use this button to turn the control unit on and off.
- When the control unit is first powered on, the Mode P is selected by default at pressure level 1.
- It turns off after 15 minutes automatically as long as other buttons are not pressed during a session.
- If other buttons are pressed during a current session, another 15 minutes starts from the time the last button is pressed.

## 2 MODE Button

- Use this button to access selection of a P, S, F cycle mode.

- Progressive Cycle Mode

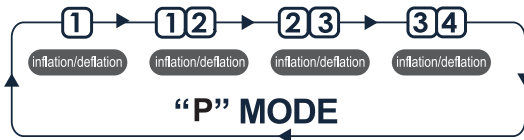

- Sequential Cycle Mode

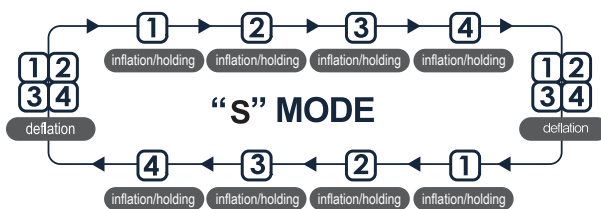

- Full Massage Cycle Mode



- In case the TARGET or MODE button is pressed during operation, the MODE light turns off and the newly selected mode turns on.

### 3 TARGET Button

- Use this button to select specific chambers.
- The default cycle mode setting is Sequential Cycle.

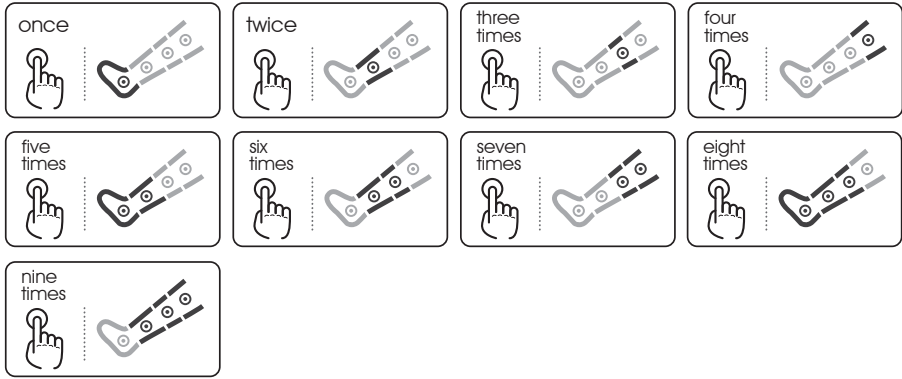

### 4 PRESSURE Button

- Use this button to adjust the pressure level. This will change the intensity of the massage.
- A lower pressure setting will apply a light massage, while a higher-pressure setting will apply a more intense massage. If the massage is too intense, lower the pressure level using this button.
- The default pressure setting is level 1.

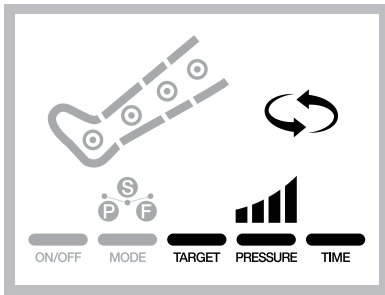

- Level 1: 60 mmHg
- Level 2: 100 mmHg
- Level 3: 140 mmHg
- Level 4: 170 mmHg

### 5 TIME Button

- Use this button to adjust the session time.
- Press the TIME button to cycle from 15 mins default to 30 minutes session time. Press again to cycle back to 15 minutes session time.

# OPERATION CYCLES

## OPERATION CYCLE OF MODE

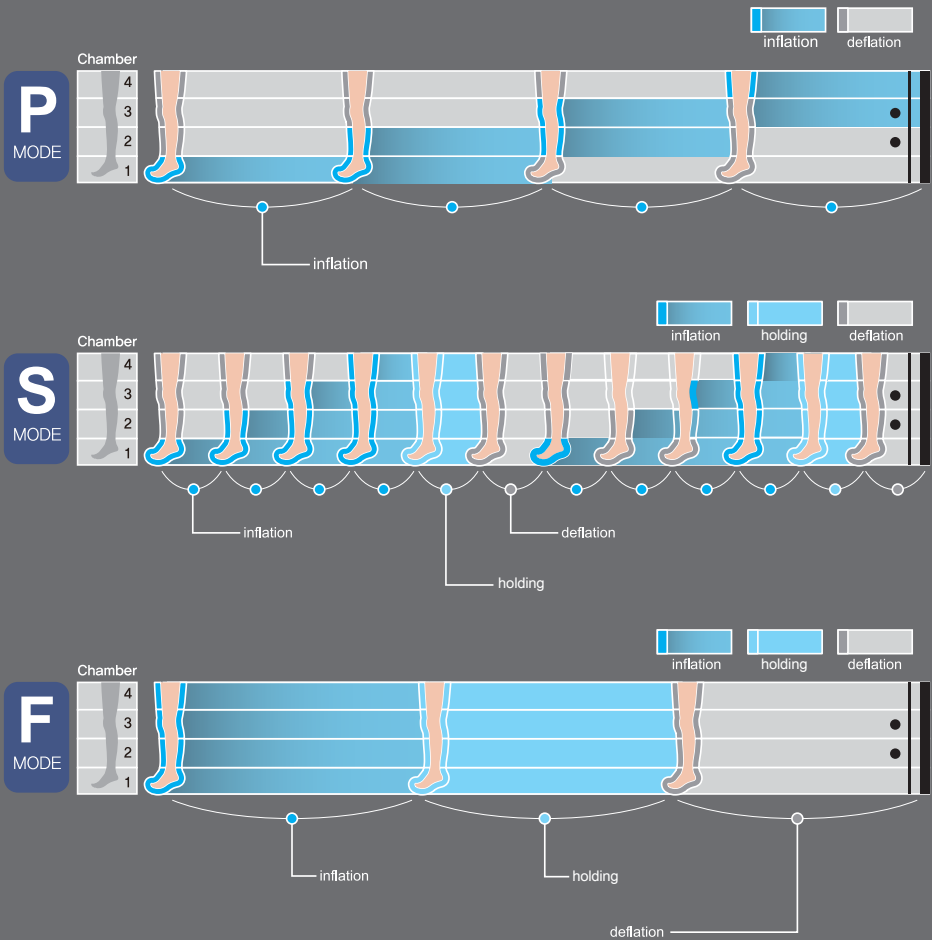

# OPERATION CYCLE OF TARGET

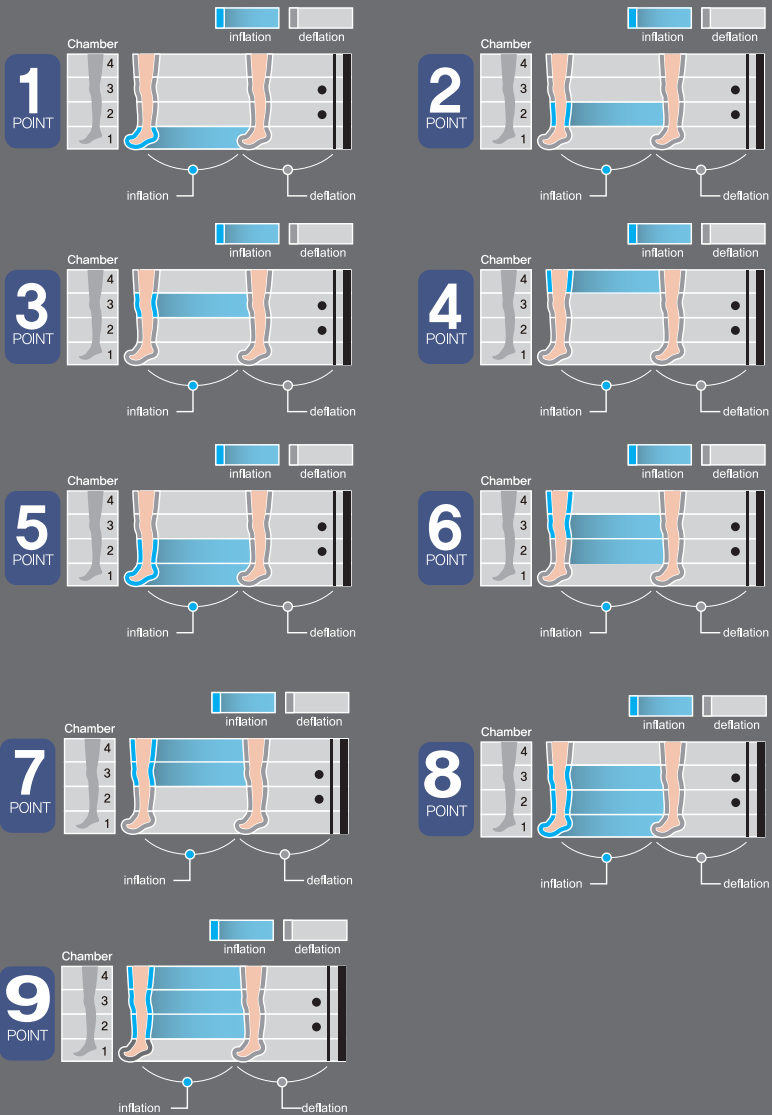

# HOW TO USE THE AIR RELAX PLUS SYSTEM

## **WARNING**

### **FOR YOUR SAFETY AND TO AVOID PROPERTY DAMAGE:**

Read this manual carefully and use as indicated. Non-Compliance may cause serious injuries or death and or severe property damage.

## **1. Set up the Control Unit**

- The control unit should be placed on a stable flat surface from where it will not slip or fall. Position the control unit so that the user can easily reach it during sessions.
- Connect the AC Adapter into the AC Adapter socket on the control unit, and then plug the AC Adapter power cord into an appropriate electrical wall outlet.
- If you will be using the system with the Air Relax battery pack (sold separately), please consult the instructions for use that accompany the battery pack.

## **WARNING**

Only use the AC Adapter Model Number EM10681P provided with the system. Use of other adapters may result in electrical shock and will void the Air Relax warranty.

## **2. Connect the Hose Plug to the Control Unit**

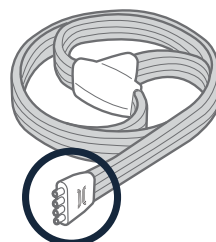
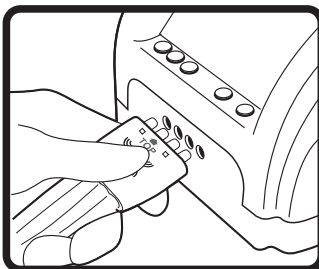
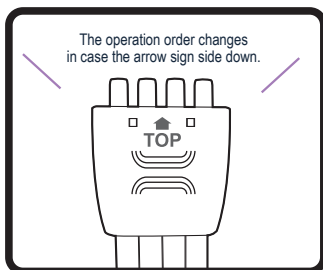

Hose plug

- 1) The hoses should not be twisted or folded.
- 2) Connect the hose plug to the air socket on the control unit making sure the arrow sign is facing up.
- 3) The hose plug should be connected fully to prevent air from leaking out.

### 3. Put on the Garment

#### CAUTION

The garment is not sterile, do not place directly against open wounds, sores, rashes, infections, or stitches. A layer of clothing between garment and skin is recommended. Remove any jewelry or watches before wearing the garment.

#### • Leg Garment

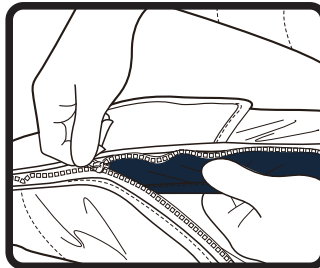
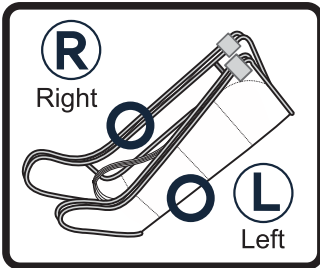

**Protecting cover**  
Cover the protecting cover  
to protect your skin.

- 1) Make sure you have the “left” and “right” garments placed on your legs accordingly.
- 2) To put on the leg garment, zip the garment halfway up, and insert your foot into the garment.
- 3) Pull the top of leg garment towards your torso.
- 4) Close the zipper all the way up to the top, being careful that your clothes are not caught in the zipper.
- 5) Place the zipper flat as in the picture and secure the Velcro strap firmly.

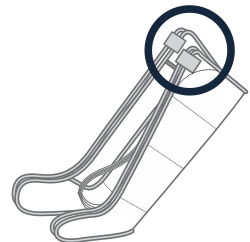
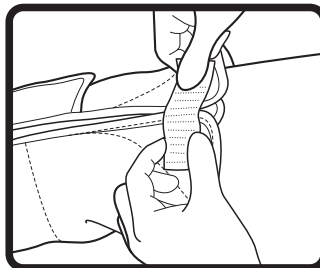
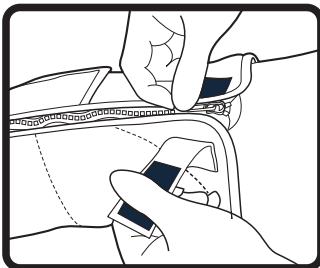

# HOW TO USE THE AIR RELAX PLUS SYSTEM

---

## CAUTION

Attach the Velcro to prevent the air pressure from causing the zipper to unzip (pop) while the upper chambers are filling up. If this happens, simply shut off your control unit and secure the zipper as suggested above.

### • Arm Garment

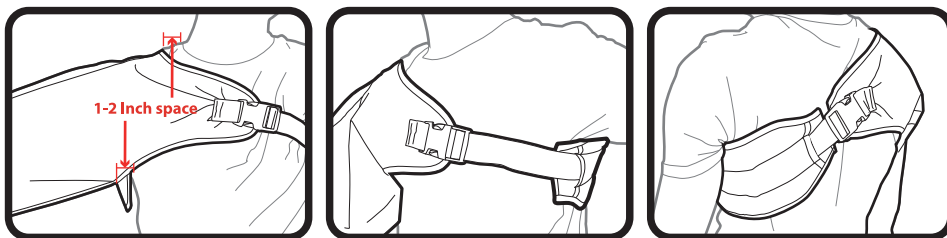

- 1) Insert the arm into the arm garment, so the zipper stays on the top of your arm.
- 2) Pull the garment over your shoulder leaving a 1-2 inch space between your neck and the garment.
- 3) Wrap the fastening strap around torso, under the free arm.
- 4) Fasten the strap at the torso and adjust the length by pulling on the buckle for a comfortable fit.

## CAUTION

Using pressure over 100mmHg (Level 2) with the arm garment is not recommend.



---

---

- **Shorts Garment**

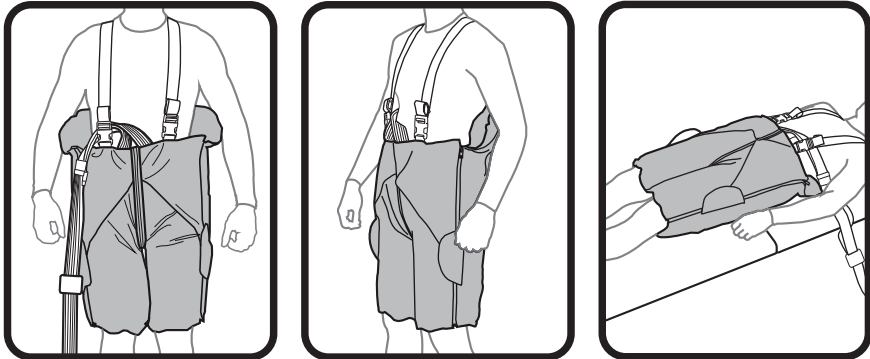

- 1) Lay the shorts garment on a bed or couch, with logo side up.
- 2) The shorts garment has two zippers on each side. Open the zippers halfway on both sides of the garment.
- 3) Get into the shorts garment and close the zippers all the way, leave them closed for the duration of the session.
- 4) The garment should not fit too tightly. If the garment is too tight, reduce the pressure immediately or turn the control unit off.
- 5) The shorts garment has two fastening straps on each side. Bring each strap at the torso and fasten it. Adjust the length by pulling the loop for a comfortable fit.

 **CAUTION**

Using pressure over 100mmHg (Level 2) with the shorts garment is not recommend. Air Relax Shorts are not intended for use in a standing or seated position. Use them laying face up on a bed or any other flat surface.

 **WARNING**

If you are pregnant or suspect you may be pregnant, do not use the Air Relax Shorts garment.

# HOW TO USE THE AIR RELAX PLUS SYSTEM

## 4. Start the Session

- The default setting is progressive cycle, 15 minutes and pressure level 1.

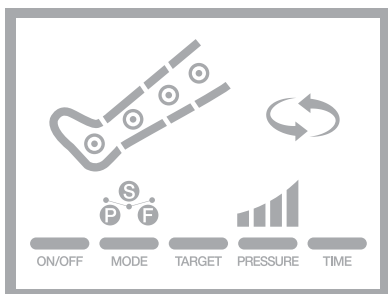

- 1) Press the ON/OFF button on the control unit to turn on the system.
- 2) Press the MODE button on the control unit to select the mode.
- 3) Press the PRESSURE button on the control unit to adjust the pressure level.
- 4) Press the TIME button on the control unit to select between the 15/30 minutes session time.

- If other buttons are pressed during a current session, another 15 minutes starts from the time the last button is pressed.
- At the start of a session, a few inflation cycles are used to calibrate the pressure based on your limb(s) or body circumference. The first cycle or two may take a longer time to fill completely.
- Recommended session time is 15-30 minutes before working out and 30-45 minutes after exercise. A 15 minutes session will provide a relaxing massage.

## 5. End the Session

- When the session is completed, the control unit will turn off automatically.
- Allow the garment to deflate for 30 seconds before you remove it.

### CAUTION

Discontinue use if you experience pain or discomfort, or if there is onset of bruising, irritation or redness during or after the session and consult your physician immediately.

# MAINTENANCE

---

- Control Unit: The exterior of the control unit can be cleaned with a soft, slightly damp cloth.

## CAUTION

The control unit is not a waterproof device. Do not apply a direct stream of any liquid onto the control unit, submerge the control unit, or allow any liquid to pool on the surface of the front panel of the control unit.

- Connector Hose: The surface of the connector hose can be cleaned using a soft, slightly damp cloth.
- Garment: Gently wipe the garments using a soft, slightly damp cloth.
- Wipe dry using a soft towel only.
- Allow the garment to air dry completely before use.

## CAUTION

- Surface wipe only.
- Do not machine wash.
- Do not dry clean.
- Do not use bleach.
- Do not iron, tumble or force heat dry.

# STORAGE

---

## CAUTION

Do not keep in extreme cold or hot temperatures below -4 °F or above +158 °F (below -25 °C or above +70 °C). Do not leave in a hot or freezing car. Do not leave the control unit in direct sunlight.

- System Operating temperature: +50 °F to +104 °F (+10 °C to +40 °C)
- System Storage temperature: -4 °F to +158 °F (-25 °C to +70 °C)
- Relative Humidity: 15 %R.H. to 90 %R.H. non-condensing
- Atmospheric pressure: 700 hpa to 1060 hPa
- Store in a cool, dry, and well-ventilated area. Optimum storage is achieved at room temperature.

# TROUBLESHOOTING

Problem	Cause	Solution
<b>The control unit does not turn on.</b>	<ul style="list-style-type: none"> <li>- No electricity</li> <li>- AC adapter not plugged in correctly</li> <li>- Low battery power</li> <li>- Internal malfunction</li> </ul>	<ul style="list-style-type: none"> <li>- Check the electrical wall outlet.</li> <li>- Verify AC Adapter is securely connected to the AC Adapter socket on the control unit.</li> <li>- Charge the external battery pack.</li> <li>- Contact Air Relax.</li> </ul>
<b>The control unit does not pump.</b>	<ul style="list-style-type: none"> <li>- Low battery power</li> <li>- Internal malfunction</li> </ul>	<ul style="list-style-type: none"> <li>- Charge the external battery pack.</li> <li>- Contact Air Relax.</li> </ul>
<b>The garments do not fully inflate.</b>	<ul style="list-style-type: none"> <li>- Damaged connectors</li> <li>- Damaged hose bundles</li>   <li>- Punctured garments</li> <li>- Internal malfunction</li> </ul>	<ul style="list-style-type: none"> <li>- Check for physical damage on connectors.</li> <li>- Check hose bundles for kinks, twists and fold.</li> <li>- Check if hose bundles are securely connected to the control unit, garments and connectors.</li> <li>- Check for punctures on garments.</li> <li>- Contact Air Relax.</li> </ul>
<b>An irregular noise</b>	<ul style="list-style-type: none"> <li>- Uneven surface</li> <li>- Internal malfunction</li> </ul>	<ul style="list-style-type: none"> <li>- Make sure the control unit is standing evenly on all four of its bumpers.</li> <li>- Contact Air Relax.</li> </ul>

## WARRANTY

The Air Relax system/accessories are warranted by the Manufacturer, against manufacturing defects in material and workmanship for a period of one year from the date of purchase from Air Relax or an Air Relax authorized reseller. In the event of any defect occurring during the warranty period, the Manufacturer will, at its option, (a) correct the defect by repair or by replacement of applicable part or component that fails as a result of such defect, without charge for the part and labor; or (b) replace the device with one of the same or then current design. The Air Relax system includes the control unit, garments, and hose bundles.

The forgoing warranty does not cover normal wear and tear or cosmetic damage, and are void if the device/accessories are not used in accordance with the User Manual, are otherwise misused or modified in any way, and or repaired by anyone other than an authorized service representative of the Manufacturer. This warranty expressly excludes transportation, shipping or insurance costs, or defects, damages or failure resulting from misuse, abuse, improper or abnormal usage, or neglect.

EXCEPT AS PROVIDED ABOVE, AIR RELAX MAKES NO EXPRESS WARRANTY OR ANY IMPLIED WARRANTY, INCLUDING THOSE OF MERCHANTABILITY AND FITNESS FOR A PARTICULAR PURPOSE OR USE, AND ARE LIMITED IN DURATION AS STATED ABOVE EXCEPT AS EXPRESSLY STATED ABOVE, AIR RELAX SHALL HAVE NO LIABILITY OR RESPONSIBILITY TO ITS CUSTOMERS, OR ANY OTHER PERSON OR ENTITY. WITH RESPECT TO ANY LIABILITY, LOSS OR DAMAGE CAUSED DIRECTLY OR INDIRECTLY BY USE OR PERFORMANCE OF THE PRODUCT OR ARISING OUT OF THE USE, INABILITY TO USE OR ANY BREACH OF THIS WARRANTY, INCLUDING BUT NOT LIMITED TO ANY DAMAGES RESULTING FROM INCONVENIENCE, LOSS OF TIME, PROPERTY OR INCOME, OR ANY INDIRECT, SPECIAL, INCIDENTAL OR CONSEQUENTIAL DAMAGES OF ANY KIND.

Some countries or states do not allow the exclusion or limitations of incidentals or consequential damages, so the above limitations or exclusion may not apply to you. The warranty gives you specific legal rights, and you may also have other rights which vary from country to country or state to state. In the event of a product defect covered by the foregoing warranty during the applicable warranty period send the product to an Air Relax authorized service center, postage prepaid and insured and an indication of the nature of the defect identified.

All replacement parts and products become the property of Air Relax. New or reconditioned parts and products may be used in the performance of a Warranty service. Repaired or replaced parts and products are warranted for the remainder of the original warranty period only. You will be charged to repair or replace parts and products made after the expiration of the applicable Warranty periods.

## RETURN POLICY

This policy is only applicable if you are the end user and you purchased the equipment directly from Air Relax or an Air Relax authorized reseller.

In the unlikely event that you are not satisfied with your purchase, you may return it within (30) days of the purchase date. All returns and exchanges are subject to the conditions listed below.

1. Returns and exchanges must have a Return Merchandise Authorization (RMA) number. Obtain an RMA number by contacting Air Relax or an Air Relax authorized reseller. Returned items without an RMA will not be eligible for a credit to your account.
2. Returns must be received within 15 days of RMA issuance.
3. Product and packaging must be returned in new and undamaged condition. Any product(s) showing signs of wear or being soiled in any way will be deemed “unacceptable” and you will be so notified. Unacceptable returns/or exchanges may be reshipped to you following payment of an inspection/shipping fee.
4. Returned items will be subject to a 10% restocking fee. A returned item is an item that is being sent back for a refund.
5. If you refuse delivery of your order for any reason, you will be refunded the cost of your order less the shipping fees once your item is received and inspected.
6. All partial or full refunds will be posted to the credit card used for purchase.
7. Air Relax is not responsible for items lost or damaged during shipping.

## RETURN SHIPPING DIRECTIONS

Step 1: Contact Air Relax or an Air Relax authorized reseller to obtain a Return Merchandise Authorization (RMA) number.

Step 2: Place item(s) with original packaging and all original shipping documentation inside the shipping box. Be sure to include your name, order number (if applicable), contact information, reason for return/exchange, and RMA number in the shipment so that we can properly process your return/exchange.

Step 3: Ensure your name, address and RMA number are also on the outside of the shipping box, and ship to Air Relax or an Air Relax authorized reseller.

Step 4: Ship your return with package tracking and insurance. Air Relax is not responsible for items lost or damaged during shipping.

Registering your product will help us provide you with quicker and more efficient service and support and assure you get the most out of your warranty.

Register your product at <https://www.air-relax.com/pages/registration>

# SPECIFICATIONS

## AIR RELAX PLUS MODEL AR-3.0

<b>Rating Input</b>	18 V $\overline{\text{---}}$ , 2 A
<b>AC Adapter</b>	Input: 100-240 V~, 50-60 Hz, 60 W / Output: 18 V $\overline{\text{---}}$ , 3.15 A
<b>Battery Pack (Optional)</b>	14.4 V $\overline{\text{---}}$ , 5000 mAh, 72 Wh
<b>Type of protection against electric shock</b>	Class II
<b>Degree of safety of application in the presence of a flammable anesthetic mixture with air or with oxygen or nitrous oxide</b>	Equipment not suitable for use in the presence of a flammable anesthetic mixture with air or with oxygen or nitrous oxide.
<b>Mode of operation</b>	Continuous
<b>Time (Selectable)</b>	15, 30 minutes
<b>Pressure Range</b>	60 mmHg – 170 mmHg
<b>Dimensions (Control Unit)</b>	9.4 inch X 4.7 inch X 7.4 inch (240 mm X 120 mm X 190 mm)
<b>Weight (Control Unit)</b>	4.8 lbs. (2.2 kg)



This marking on the show on the product or its literature, indicates that is should not be disposed with other household waste at the end of its working life, to prevent possible harm to the environment or human health from uncontrolled waste disposal, please separate this from other types of wastes and recycle it responsibly to promote the sustainable reuse of material resources.

Household users should contact either the retailer where they purchased this product, or their local government office, for details on where and how they can take this time for environmentally safe recycling. Business users should contact their supplier and check the terms and conditions of the purchase contract. This product should not be mixed with other commercial wastes for disposal.

CE

# AIR RELAX® PLUS



9535 Brasher Street  
Pico Rivera, CA 90660 USA  
+1.525.821.5225  
[www.air-relax.com](http://www.air-relax.com)  
[www.air-relax.eu](http://www.air-relax.eu)

